

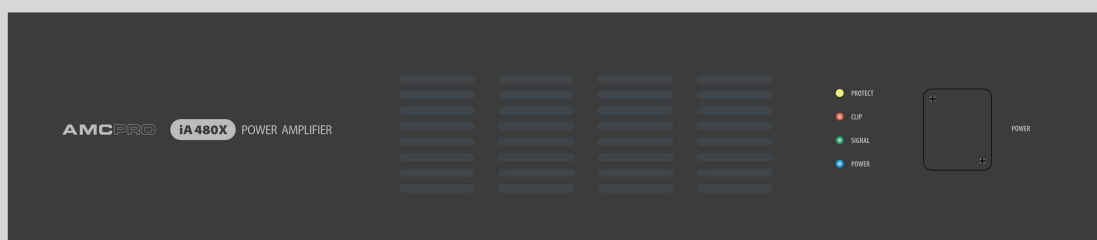

iA 480X

Power amplifier



User manual

## IMPORTANT SAFETY INSTRUCTIONS

### CAUTION!

THIS PRODUCT UTILIZES A LASER. USE OF CONTROLS OR ADJUSTMENTS OR PERFORMANCE OF PROCEDURES OTHER THAN THOSE SPECIFIED HEREIN MAY RESULT IN HAZARDOUS RADIATION EXPOSURE. DO NOT OPEN COVERS AND DO NOT REPAIR YOURSELF. REFER SERVICING TO QUALIFIED PERSONNEL.

### WARNING:

TO REDUCE THE RISK OF FIRE, ELECTRIC SHOCK OR PRODUCT DAMAGE, DO NOT EXPOSE THIS APPARATUS TO RAIN, MOISTURE, DRIPPING OR SPLASHING AND THAT NO OBJECTS FILLED WITH LIQUIDS, SUCH AS VASES, SHALL BE PLACED ON THE APPARATUS.



When using this electronic device, basic precautions should always be taken, including the following:

1. Read all instructions before using the product.
2. Do not use this product near water (e.g., near a bathtub, washbowl, kitchen sink, in a wet basement or near a swimming pool etc).
3. Use this device when you are sure that amplifier has a stable base and it is fixed securely.
4. This product, in combination with loudspeakers may be capable of producing sound levels that could cause permanent hearing loss. Do not operate for a long period of time at a high volume level or at a level that is uncomfortable. If you experience any hearing loss or ringing in the ears, you should consult with otorhinolaryngologists. The product should be positioned so that proper ventilation is maintained.
5. The product should be located away from heat sources such as radiators, heat vents, or other devices (including amplifiers) that produce heat.
6. The product should be connected to a power supply that is described in the operating instructions or are marked on the product. Replace the fuse only with one of the specified type, size and correct rating.
7. The power supply cord should be undamaged and never share an outlet or extension cord with other devices so that the outlet or extension cord's power rating is exceeded. Never leave device plugged into the outlet when it is not being used for a long period of time.
8. Care should be taken so that objects do not fall into, and liquids would not be spilled through, the enclosure's openings.
9. The product should be serviced by qualified service personnel if:
  - The power supply cord or the plug has been damaged.
  - Objects have fallen into or liquid has been spilled on the product.
  - The product has been exposed to rain.
  - The product has been dropped or the enclosure damaged.
10. There are some areas with high voltage inside, to reduce the risk of electric shock do not remove cover of the amplifier. The cover should be removed by the qualified personnel only.

**No user serviceable parts inside.**

## CONTENTS:

Before you start

Introductions	4
Features	4

Operation

Front panel	5
Rear panel	5
Function description	6
Output terminal	7

Controls and connectors

Connectors	8
Cable wiring examples	8

Specifications

General specifications	11
------------------------	----

## Introduction

**iA** a group of 100 V amplifiers with different output power configuration for professional contractor market. Fan powered cooling system, rack mount. **iA** amplifiers are designed to work under hard conditions and required minimum maintenance after installation. Used in a medium and large public address or voice evacuation systems.

## Features

- Balanced phoenix inputs.
- Stereo RCA input.
- Input gain control.
- LINK output.
- Ground lift.
- Phoenix output connectors.
- DC 24V external power supply input.
- DC 24V link connector.
- Power, signal, protect and clip indicators.
- Power switch cover.

## 5 Operation

### Front Panel



1. Protect indicator
2. Signal clipping indicator

3. Signal indicator
4. Power indicator
5. Power switch

### Rear Panel

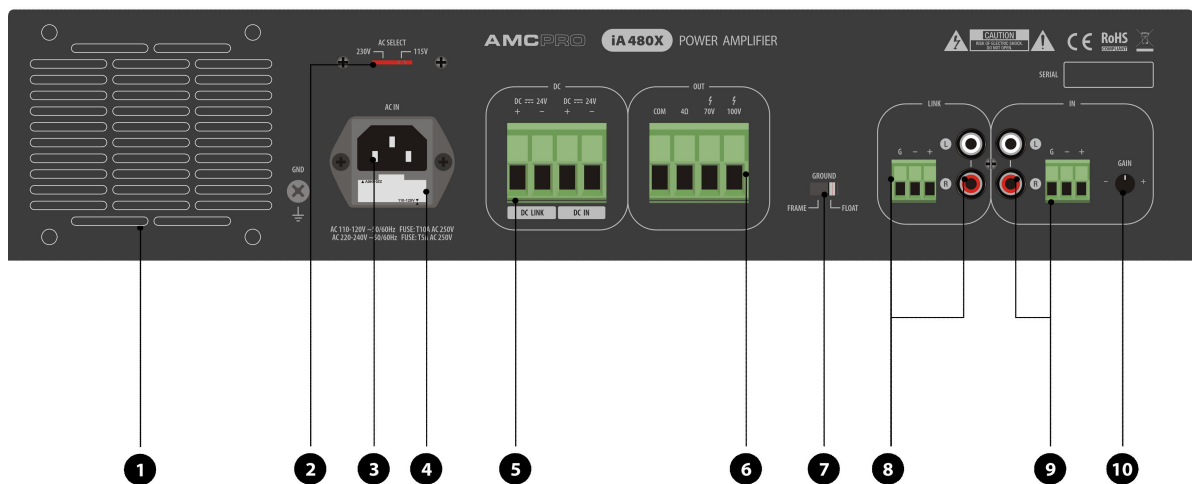

1. Cooling vent
2. Voltage selector
3. Main power connector
4. Holder for AC fuse
5. Link for DC 24V power supply
6. Input for DC 24V power supply
7. Amplifiers output

8. Ground lift switch
9. Link output
10. Balanced phoenix and stereo RCA input
11. Input gain control

### Functions description

#### **PROTECT INDICATOR**

This LED lights up for a few seconds after the iA 480X is powered on and then turns off if the amplifier is not damaged. This LED also lights when overheating or other service problems occur. It is normal for the protection LED to fade slowly when the amplifier is powered off.

#### **SIGNAL CLIPPING INDICATOR**

Lights whenever the channel is outputting signal at full strength and signal is distorted. Reduce signal level to ensure undistorted output signal.

#### **SIGNAL INDICATOR**

LED in the front panel indicates audio signal of the amplifier.

#### **POWER INDICATOR**

This LED indicates status of the main power. The LED lights up if the amplifier is powered on.

#### **POWER SWITCH**

Power switch is hidden with cover to prevent illegal or incidental use. Remove cover using Phillips screwdriver and use this switch to power on or off the amplifier. The power LED in the front panel lights up if the amplifier is powered on.

#### **COOLING VENT**

Cool air is pulled in through the front panel fan filters and eliminated through the rear panel vents.

#### **VOLTAGE SELECTOR**

This switch is used to set the input voltage to the power supply. Setting the power supply voltage switch to the incorrect input voltage could damage the amplifier. The correct voltage is determined by the country where the amplifier will be used.

#### **MAIN POWER CONNECTOR**

Power connector is designed for main powers connecting to amplifier. This connector is combined with fuse holder.

#### **HOLDER FOR AC FUSE**

Please use 10A, 250V fuse if amplifier is used in ~230V 50Hz electricity system and 20A, 250V fuse if amplifier is used in ~115V 60Hz system.

#### **LINK FOR DC 24V POWER SUPPLY**

This connector is designed to link the DC 24V power to additional amplifier. DC IN and DC LINK connectors are connected with each other directly, inside the amplifier.

#### **INPUT FOR DC 24V POWER SUPPLY**

This connector is designed to power up amplifier when the main power is unavailable. Use only 24V power supply or batteries and take attention to polarity during the wiring. If both, AC and DC power are connected, amplifier will use main AC power.

#### **AMPLIFIERS OUTPUT**

Use this connector to connect amplifier to the loudspeakers.

#### **GROUND LIFT SWITCH**

To eliminate a ground loop, set ground switch to FLOAT position and otherwise to connect a ground to amplifiers chassis.

#### **LINK OUTPUT**

Connect outgoing audio signal from stereo RCA and Phoenix connectors to additional amplifier. Input and link connectors are connected with each other directly.

## BALANCED PHOENIX AND STEREO RCA INPUT

Connect audio signal to electronically balanced phoenix connector or to stereo RCA. Please note that the iA480X needs at least 0 dBu to achieve maximum power.

## INPUT GAIN CONTROL

This control allows you to precisely adjust the input level of the signal arriving at the rear-panel input connectors. At their fully counterclockwise position, the signal is attenuated by -80 dB. At their fully clockwise position, the signal is not attenuated. When 0dBu of signal arrives at the input and the input level controls are set to their fully clockwise position (0dBu), the Amplifier delivers full power.

Output terminal

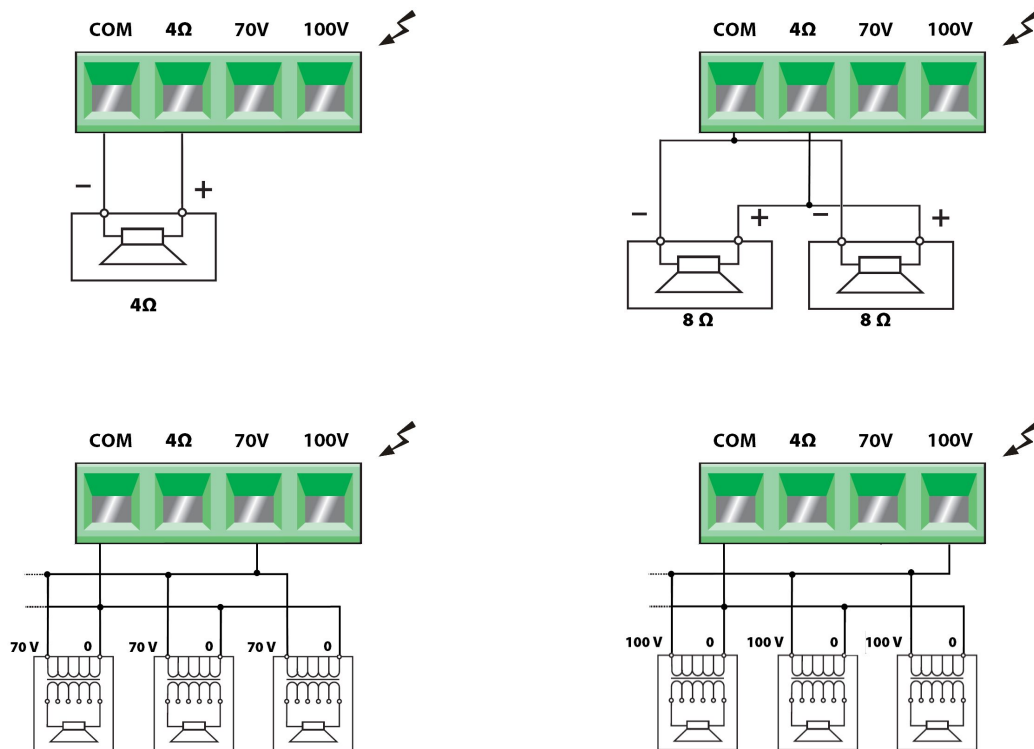

Amplifiers output can run only one configuration at the same time. Operating amplifiers using 4 Ω and 70 or 100 volt concurrently may cause damage to the amplifier or connected speakers.

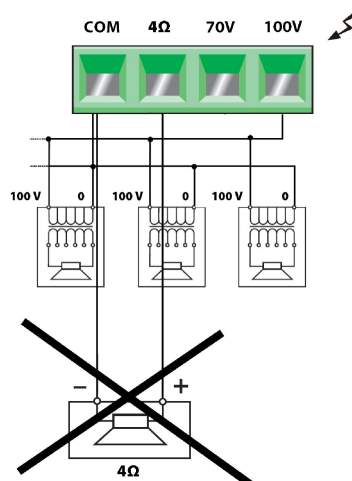

## Connectors

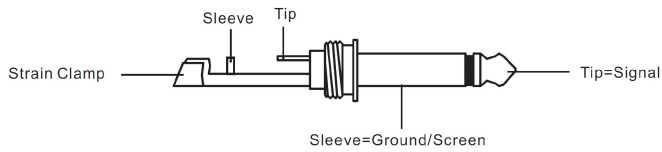

## TS connector

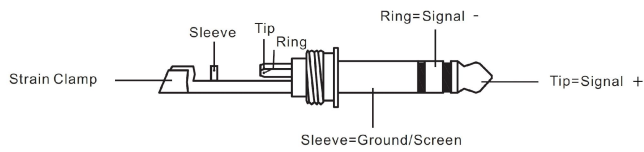

## TRS connector

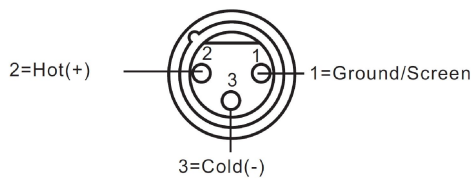

XLR male connector

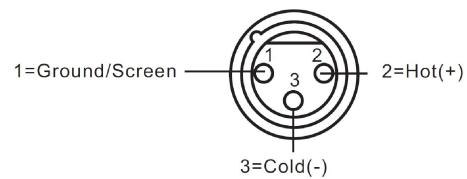

XLR female connector

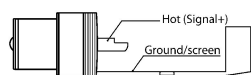

RCA connector

## Cable wiring examples



Cable to balanced input from balanced output. TRS connectors.





Cable to unbalanced input from balanced output. TRS and TS connectors.



Cable to balanced input from unbalanced output. TS and TRS connectors.



Cable to unbalanced input from unbalanced output. TS connectors.

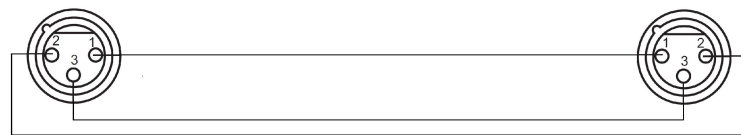

Cable to balanced input from balanced output. XLR connectors.

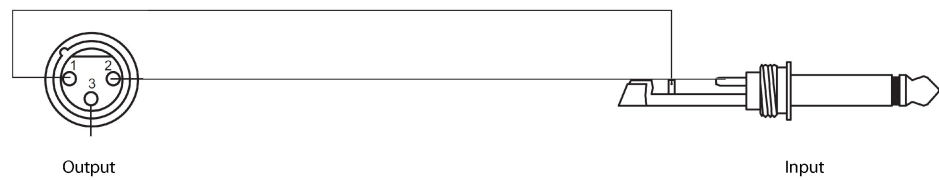

Cable to unbalanced input from balanced output. XLR and TS connectors.

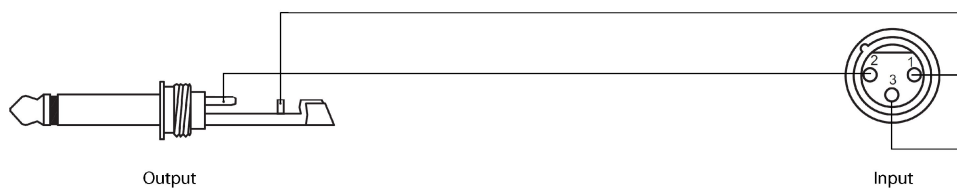

Cable to balanced input from unbalanced output. TS and XLR connectors.

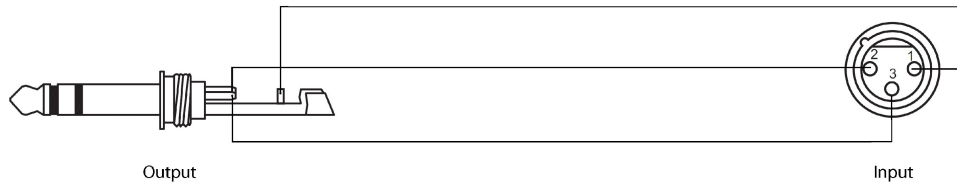

Cable to balanced input from balanced output. TRS and XLR connectors.

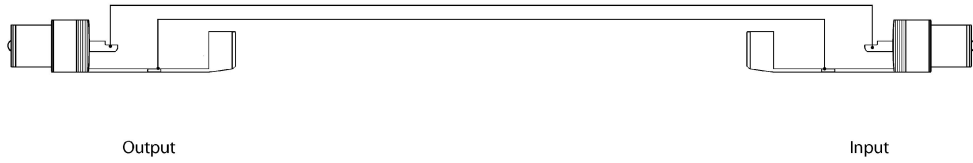

RCA cable.



Cable to unbalanced input from RCA output. RCA and TS connectors.

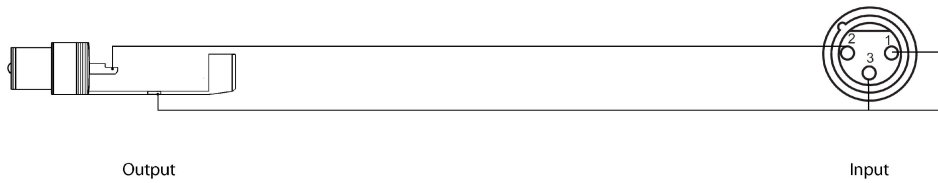

Cable to balanced input from RCA output. RCA and XLR connectors.

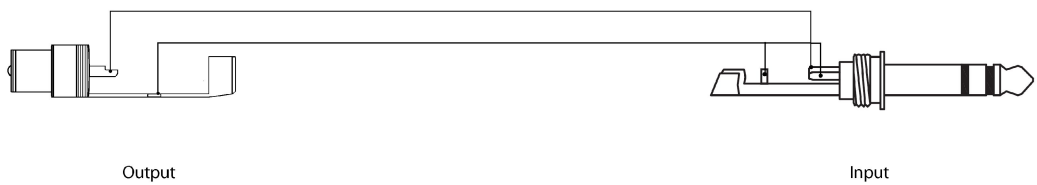

Cable to balanced input from RCA output. RCA and TRS connectors.



Cable to RCA input from balanced output. RCA and XLR connectors.

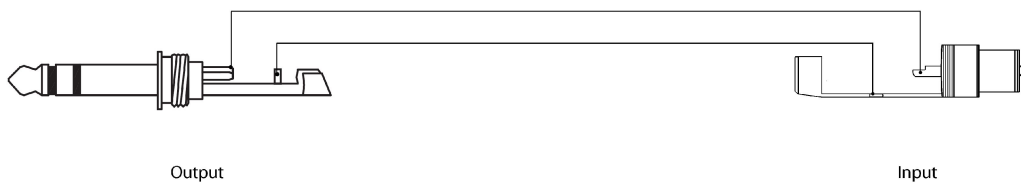

Cable to RCA input from balanced output. RCA and TRS connectors.

## General specifications

<b>Power supply</b>	AC 220/110 V 50/60 Hz or DC 24V
<b>Output power</b>	480 W
<b>AC power consumption</b>	850W
<b>Total harmonic distortions</b>	< 1 %
<b>Input sensitivity</b>	0 dBu
<b>S/N ratio</b>	85 dB
<b>Frequency response</b>	30 Hz – 20 kHz +/- 3 dB
<b>Protection</b>	Short circuit, thermal, current limit, DC offset, current inrush, RF protection, Turn on/Turn off muting.
<b>Cooling</b>	Fan forced air.
<b>Indicators</b>	Power, protection, signal, clip.
<b>Controls</b>	Power switch, input gain, ground lift.
<b>Output</b>	4 $\Omega$ , 70 V, 100V
<b>Weight</b>	14,6 kg
<b>Dimensions</b>	88 mm (H) x 420 mm (W) x 280 mm (D)